

# University of Cincinnati

Date: 3/24/2017

I, Kristin Ridge, hereby submit this original work as part of the requirements for the degree of Master of Architecture in Architecture.

It is entitled:

**The American Islamic Cultural Center**

Student's name: Kristin Ridge

This work and its defense approved by:

Committee chair: Elizabeth Riorden, M.Arch.

Committee member: Christoph Klemmt, A.A. Dipl.



24658

# The American Islamic Cultural Center

A thesis submitted to the  
Graduate School  
of the University of Cincinnati  
in partial fulfillment of the  
requirements for the degree of

Master of Architecture

in the School of Architecture and Interior Design  
in the college of Design, Architecture, Art, and Planning

by

Kristin Alexandra Ridge, 2017

B.F.A. Arch, Savannah College of Art and Design (SCAD), 2013

Committee Chair: Elizabeth H. Riorden

Committee Member: Christoph Klemmt

# ABSTRACT

Despite the fact Islamic architecture historically follows very traditional typologies that have remained unchanged for nearly thousands of years, the functions and aesthetics it serves are largely of another people and time outside of 21st century westernized countries. Its inability to evolve and adapt characteristics specific to modern western values come at a sensitive time when American-Muslims find themselves at the center of the nations political stage, and ultimately misrepresents their unique position within our society. What is currently being created does not fully explore new forms of Islamic architecture and lacks the stylistic and programmatic diversity that is necessary towards repairing and building stronger communities. Because of this, many members outside of the Muslim community are hardly presented with the opportunity to engage, interact with, and learn more about Islam and its complex history.

To address this issue, this thesis aims to redefine traditional religious Islamic architecture and its role throughout western countries in the 21st century by designing a modern

Islamic cultural center to be in a neighborhood outside of Minneapolis, MN, known for its large American-Muslim population with many second and third generation immigrants struggling to integrate themselves into aspects of western society. This cultural center will consider how to better facilitate catering to all members of the community, Muslim and non-Muslim, and respond to critical questions, as well as issues of trust and safety that are facing Muslims today. A non-traditional building design and its components will be presented and will include programmatic elements meant to engage a diverse user group such as: a mosque for worship, a library for religious texts, a public gallery with rotating exhibitions pertaining to Islamic art and culture, and a place for leisure such as a café or restaurant. As a result of this modern cultural center, it will produce a new Islamic architectural language that is productive, relevant, and relatable to all members of the American-Muslim population while also being outward looking, accessible, and embracing to users outside of the Muslim community – thus, a venue for convergence.



*A special thanks to my friends and family who have encouraged me with their love and support throughout my education, especially the thesis process. I would also like to thank my thesis committee and mentors at DAAP for their valuable feedback, constructive criticism, and guidance.*

# TABLE OF CONTENTS

|   |    |
|---|----|
| Abstract                                  | ii |
| Acknowledgements                          | iv |
| Table of Figures                          | vi |
| Introduction                              | 10 |
| <b>Background</b>                         |    |
| Islamic Architecture as a Cultural Medium | 15 |
| Islamic Cultural Center                   |    |
| <i>Situation/Problem</i>                  | 18 |
| <i>Precedent</i>                          | 22 |
| <i>Literature</i>                         | 26 |
| <b>Project</b>                            |    |
| Site                                      | 29 |
| Program                                   | 31 |
| Design Guidelines                         | 34 |
| Outcome                                   | 36 |
| Bibliography                              | 47 |

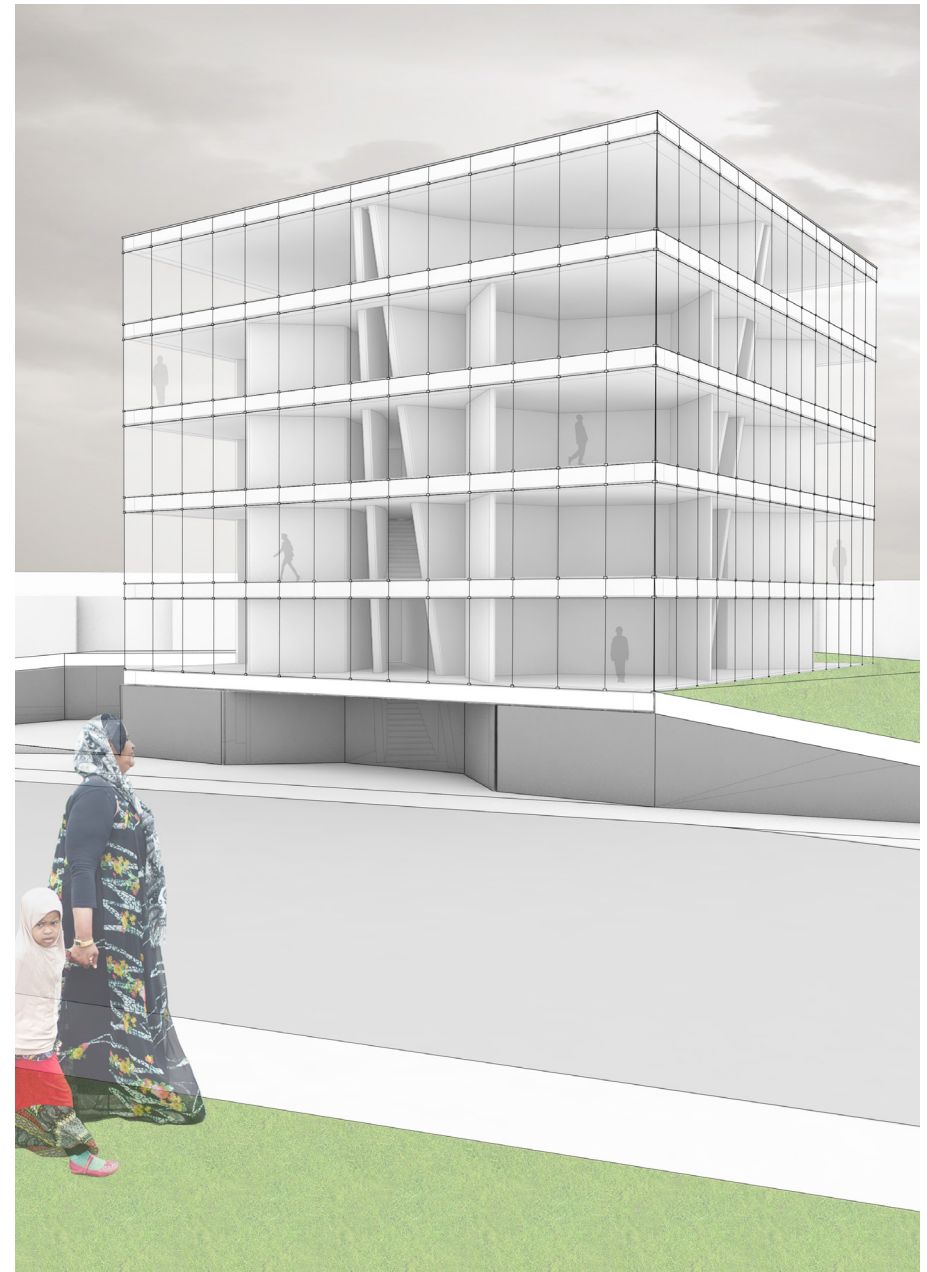

Figure 1.1.



# List of Illustrations

## 1. Table of contents:

Figure 1.1. Ridge, Kristin. Image.

## 2. Introduction:

Figure 2.1 – Adapted Image: <https://starsinsymmetry.wordpress.com/2013/12/>

Figure 2.2 – Adapted Image: Michell, George. Architecture of the Islamic world: Its History and Social Meaning.

## 3. Background:

Figure 3.1 – Adapted Image: Hess, Peter. <https://sites.utexas.edu/culturescontexts/2015/03/08/islamic-extremist-iconoclasm-and-its-christian-precedents/>

Figure 3.2 – Adapted Image: Kaaba, Mecca. <https://en.wikipedia.org/wiki/Kaaba>

Figure 3.3 – Adapted Image: Xuan, Christine: <http://www.karinablog.com/2015/03/granada-alhambra.html>

Figure 3.4 – Collage: Ridge, Kristin. Drawing. Adapted Image: Nupur, Acharjya. <http://mymirusing.blogspot.com/2014/09/al-zawawi-mosque-muscat.html>

Figure 3.5 – Adapted Image: Alpeyrie, Jonathan: <http://america.aljazeera.com/watch/shows/consider-this/Consider-This-blog/2013/12/30/photos-provide-aninsidelookatsomalicomunityinminneapolis.html>

Figure 3.6 – Adapted Image: Alpeyrie, Jonathan: <http://america.aljazeera.com/watch/shows/consider-this/Consider-This-blog/2013/12/30/photos-provide-aninsidelookatsomalicomunityinminneapolis.html>

Figure 3.7 – Adapted Graphic: Goldman, Adam: <https://www.washingtonpost.com/graphics/national/isis-suspects/>

Figure 3.8 – Ridge, Kristin. Diagram. March 2017.

Figure 3.9 – Adapted Image: Buro Koray Duman Architects. 2015. <http://burokorayduman.com/projects/slides/islamic-center/index.htm>

Figure 3.10 – Adapted Image: Buro Koray Duman Architects. 2015. <http://burokorayduman.com/projects/slides/islamic-center/index.htm>

Figure 3.11 – Adapted Image: Winstanley, Tim. 2011. <http://www.archdaily.com/162101/ad-classics-institut-du-monde-arabe-jean-nouvel>

Figure 3.12 – Adapted Image: Buro Koray Duman Architects. 2015. <http://burokorayduman.com/projects/slides/islamic-center/index.htm>

Figure 3.13 – Adapted Image: Buro Koray Duman Architects. 2015. <http://burokorayduman.com/projects/slides/islamic-center/index.htm>

Figure 3.14 – Collage: Ridge, Kristin. Drawing. Adapted Image: Edward Helmore. 2017. <https://www.theguardian.com/us-news/2017/jan/23/womens-march-poster-munira-ahmed-shepard-fairey-interview>

## 4. Project:

Figure 4.1 – Ridge, Kristin. Image. March 2017.

Figure 4.2 – Ridge, Kristin. Diagram. March 2017.

Figure 4.3 – Ridge, Kristin. Diagram. March 2017.

Figure 4.4 – Ridge, Kristin. Diagram. March 2017.

Figure 4.5 – Ridge, Kristin. Diagram. March 2017.

Figure 4.6 – Ridge, Kristin. Diagram. March 2017.

Figure 4.7 – Ridge, Kristin. Diagram. March 2017.

Figure 4.8 – Ridge, Kristin. Diagram. March 2017.

Figure 4.9 – Ridge, Kristin. Floor Plan + Diagram. March 2017.

Figure 4.10 – Ridge, Kristin. Diagram. March 2017.

Figure 4.11 – Ridge, Kristin. Floor Plan + Diagram. March 2017.

Figure 4.12 – Ridge, Kristin. Image. March 2017.

Figure 4.13 – Ridge, Kristin. Image. March 2017.

Figure 4.14 – Ridge, Kristin. Image. March 2017.



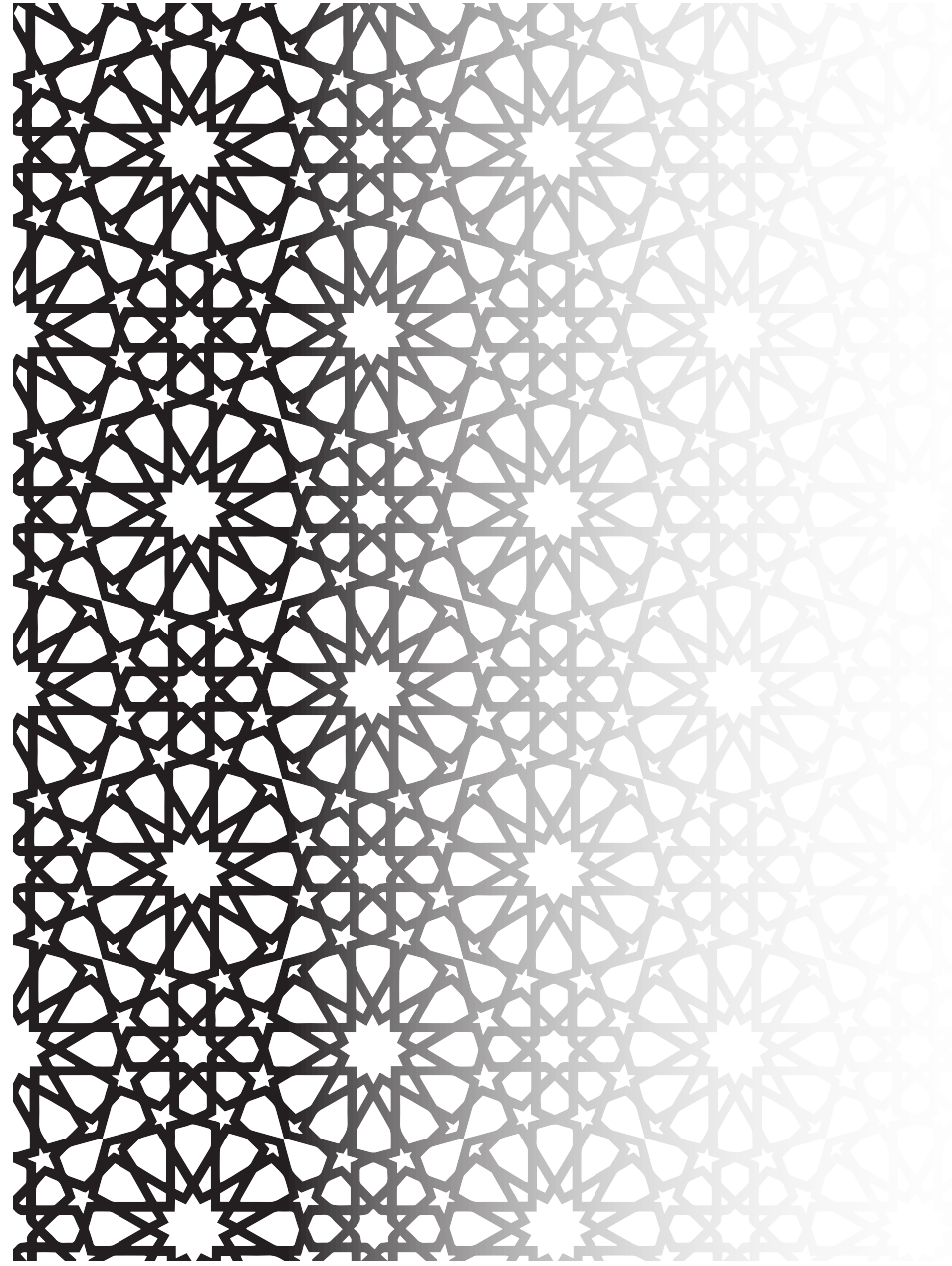

## INTRODUCTION

Figure 2.1. Traditional Islamic 8 pointed star pattern.

## EMBRACING NEW FORMS OF ISLAMIC ARCHITECTURE

This thesis discusses how most Islamic architecture, sacred and non-sacred, has been defined by a set of principles yet to evolve throughout history. Some of these include traditional ideals and aesthetics that convey the “Islamic Image”, such as: ornate motif design, repetitive colonnades, arches, domes, minarets, inward facing courtyards, and separation of men and woman, and hierarchies of space for worship.<sup>1</sup> While historically important, they express the ideals of a time and place that was sometimes isolated and guarded from influence of the outside world. Consequentially, to transplant such ideals and aesthetics into a modern western setting could be considered a misrepresentation of how spirituality, and its perception within society have managed to evolve. This is important to consider as many western cultures have begun to shape their perception of Islam from a series of recent events that are quickly taking over the global-political stage.

<sup>1</sup> Holod, Renata, and Hasan-Uddin Khan. *The mosque and the modern world: architects, patrons and designs since the 1950s*. (London: Thames and Hudson, 1997): 13.

The design proposal incorporates the program of a modern Islamic Cultural Center in the United States that aims to explore new design alternatives that are symbolic of current times and values to the west. This document will define the principles of traditional Islamic architectural typologies and how it may influence the perceptions westerners have on the Muslim community, how the American-Muslim community is affected by this, and ultimately seek to analyze the dialogue between the two.

At the architectural scale, the requirements of existing mosques and auxiliary spaces will be analyzed through set of historical and contemporary precedents. The historical example to be analyzed is the Islamic Kulliye, which dates back to the early 16th century Ottoman Empire and contains a set of program elements compatible with the proposed project. The contemporary example to be analyzed is the urban-sited proposal for an Islamic Cultural Center in New York City by Buro Koray Duman Architects. Together, by examining new and old it will become apparent how traditional principals for Islamic religious architecture can be applied and re-interpreted in 21st century America.

The proposed site is located in the Cedar-Riverside community in Minneapolis, Minnesota. The site is situated between commercial and residential zones, with a large street presence tending towards becoming a landmark of the community. This neighborhood is significant because it has the largest Somali Muslim-American population along with the highest rate for Islamic extremist group recruitments in the United States. This is due to the fact that the Somali community has isolated itself from outsiders, therefore creating a divide between them and the rest of the Minneapolis communities. While there are several Somali residential and cultural venues in the Cedar-Riverside neighborhood, many of them are unknown to locals and thus create the need for a more public venue.

The design proposal will work to ameliorate the local problems of the Cedar-Riverside Somali community, as well as the global problems of traditional Religious Islamic architecture becoming accessible, diverse and relevant spaces for 21st century western values. It will include programmatic elements to facilitate all members of the community such as a mosque for worship, a library for religious and cultural

Islamic archives for educational purposes, a museum and gallery with rotating exhibitions, and a restaurant/café with attached retail space for community recreation. It will have an abundance of publically enjoyed outdoor green space used to enhance the environmental qualities of modern design as well as to celebrate the importance of Sacred Islamic architecture's necessity for access to natural world. Together, these programmatic and environmental elements will explore underlying universalities that unite these spaces as places used to enhance the community and challenge the perception of Islam in the West.

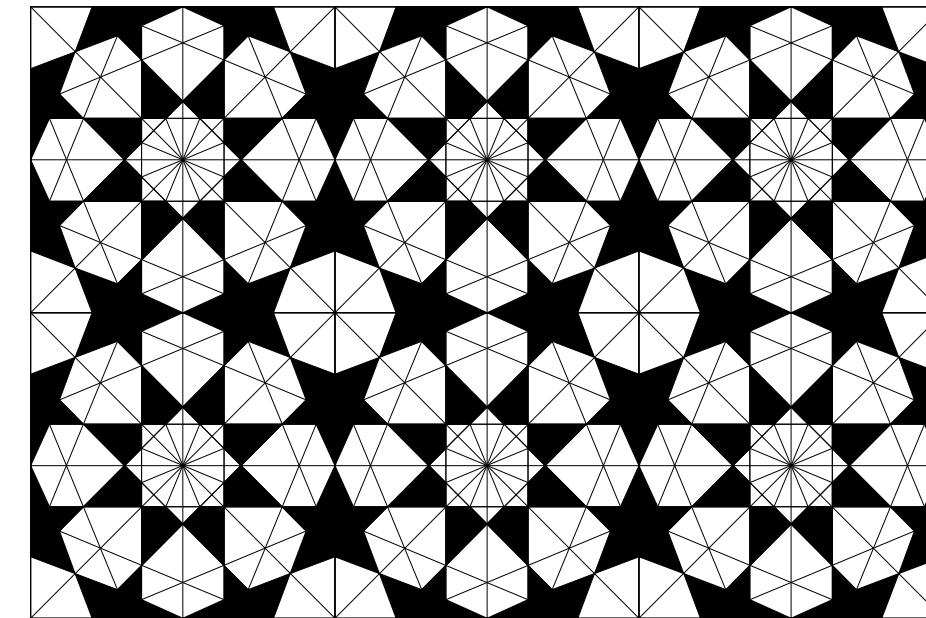
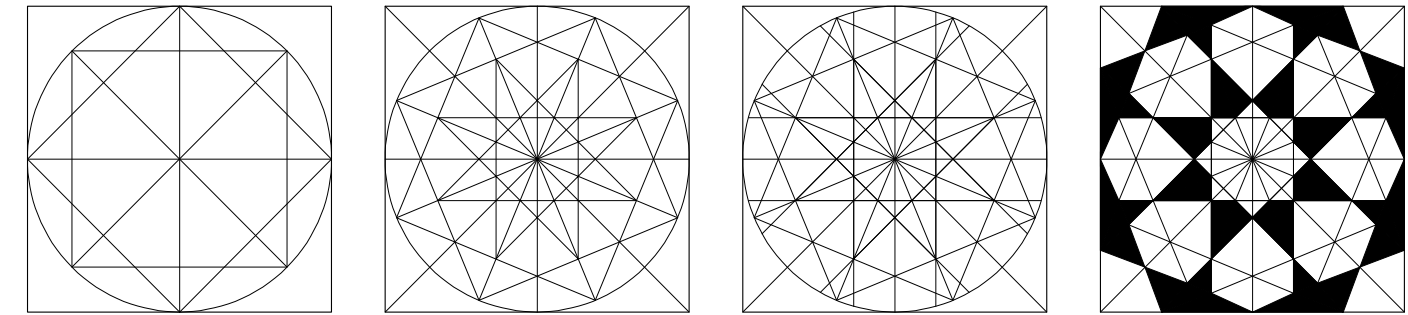

Figure 2.2. The making of a typical Islamic pattern, where the circle generates an 8 pointed star.



Figure 3.1. Byzantine example of iconoclasm and destroying of Icons.

## BACKGROUND

## ISLAMIC ARCHITECTURE AS A CULTURAL MEDIUM

Throughout all of history, perceptions of a group of people have been influenced by the many factors that make up their culture. This is especially true with construction of architecture, specifically religious architecture, in the Islamic/Muslim community because it is used as a direct expression of their faith and culture. Islamic architecture's use as a main cultural and artistic medium is largely due to the practice and belief in iconoclasm. Consequentially, this belief is what helped create the framework for some of the main design principals found throughout Islamic Architecture today.

Iconoclasm is defined as, "the destruction of religious icons and other images or monuments for religious or political motives...it is an essential aspect of monotheism, whose greatest enemy is the worship of idols."<sup>2</sup> In early Muslim history, it was mandated to remove all idols from the Ka'ba (the first mosque founded by the prophet Muhammad) in Mecca and has continued to be practiced in Islamic architecture to date.

<sup>2</sup> Vrieze, John. *Earthly Beauty, Heavenly Art: Art of Islam*. (Amsterdam: O.V., 2000): 33.

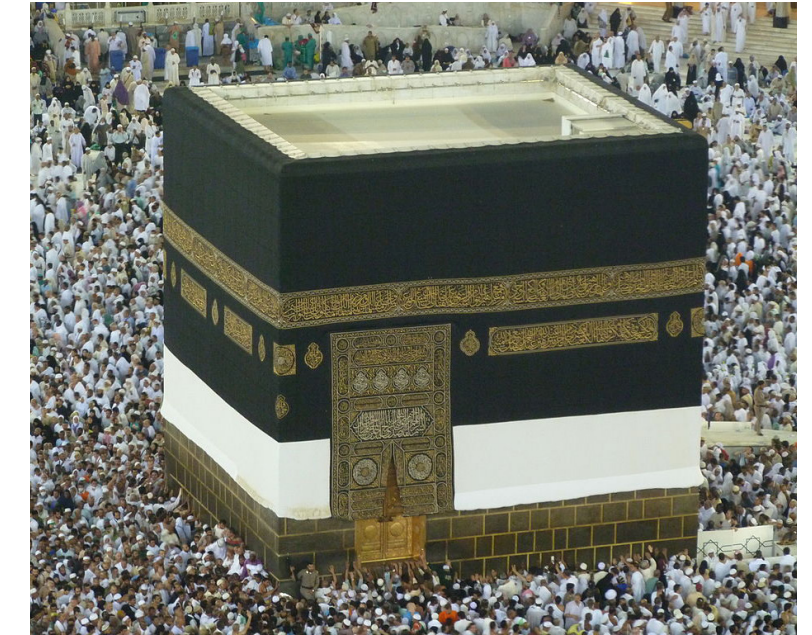

Figure 3.2. - Ka'aba - Mecca, Saudi Arabia.

As a generality, Muslims avoided depictions of living beings, whether human or animal, within sacred spaces at all costs as to avoid idolatry and the worship of false images. Because of this, sacred Islamic architecture had to develop alternative methods of expression towards their faith and culture. Where sacred spaces of other cultures had long naves adorned with stained glass windows of prominent religious figures and altars surrounded by sculptures, Islamic architecture was to be free of such representation.



Figure 3.3. Example of decorative Islamic colonnade - Granada, Spain.

As a result of this prohibition of figural depictions, Muslims began to create ornate and lavish motifs that were free of any human or animal qualities. These motives, or patterns, decorated the exterior and interior spaces of their sacred/civic places and served as the main artistic expression. It is because of these distinctive aesthetic qualities, resulting from the underlying iconoclasm, that it is especially challenging to move forward with what a 21st century re-interpretation of Islamic architecture would be today. For example, even after centuries of time Mosques are still widely constructed with a simplified and often symmetric organization that includes a large, uninterrupted spaced used for large gatherings of community prayer. These spaces are often outfitted with repetitive colonnades, arches, domes, and minarets that can be seen from the exterior. These exterior expressions consistently serve of value because they signify where important religious actions took place and therefore became a part of the prominent sacred symbols and civic monuments seen within Islam today.<sup>3</sup>

<sup>3</sup> Michell, George. *Architecture of the Islamic world: Its History and Social Meaning ; With a complete survey of key monuments and 758 illustrations, 112 in colour.* (Farnborough: Thames et Hudson, 2009): 3

### Mosque Architectural Features

- 1) Minaret (announces call to prayer)
- 2) Dome
- 3) Keel Arch Colonnade
- 4) Stair Step Crenellation
- 5) Interior Courtyard with Sahn (ablution)
- 6) Dikka
- 7) Mashrabiya (privacy screen)
- 8) Mihrab (indicates direction of Mecca)

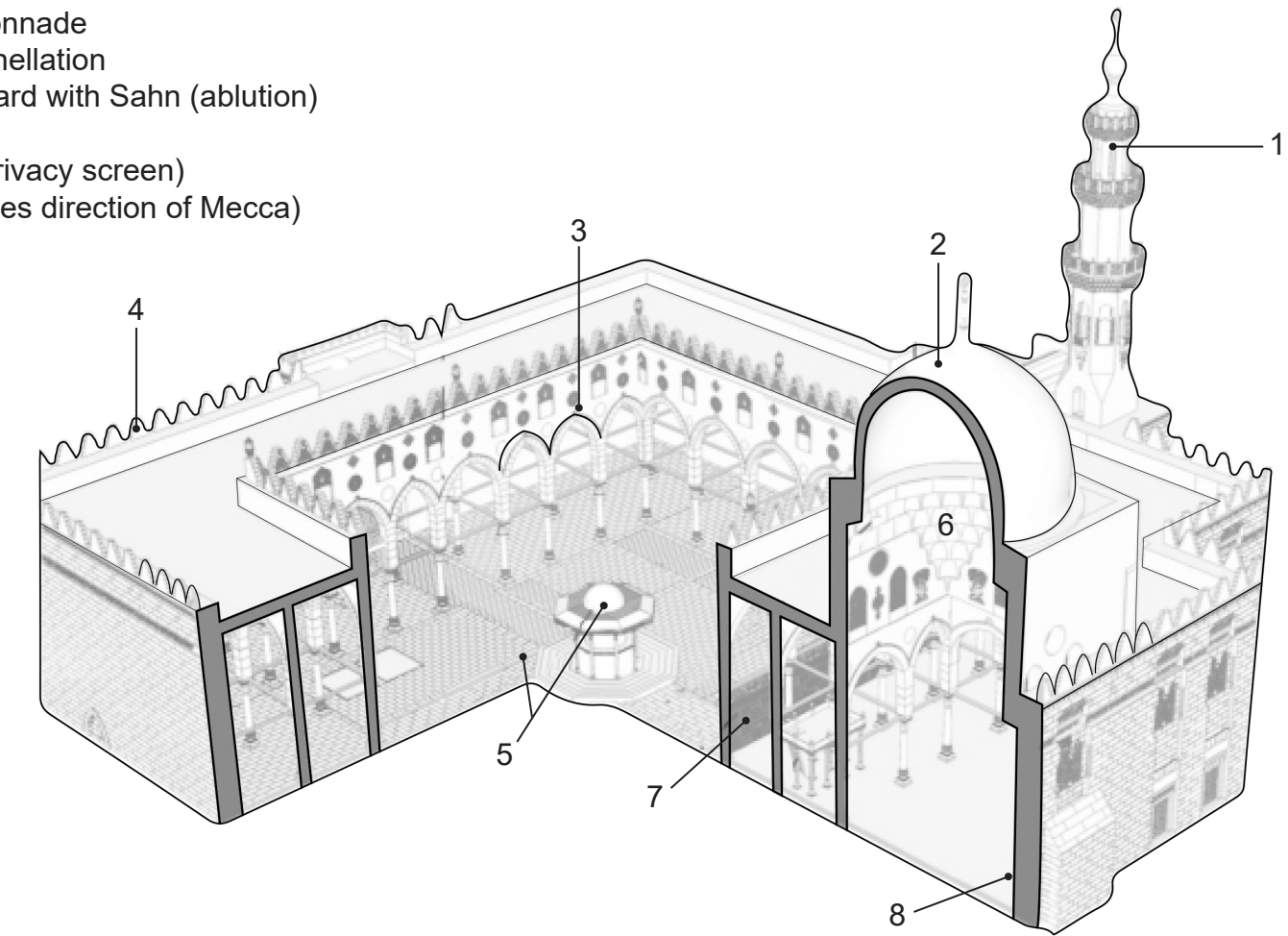

Figure 3.4. Axonometric view of traditional Mosque architectural elements.

## ISLAMIC CULTURAL CENTER

### Situation/Problem

As stated earlier, this design proposal will aim to address issues facing the American-Muslim community on the national and the local scales. The development of a new typology for Islamic architecture, one that is devoid of antiquated principals and ideals, shall better serve the representation of a more progressive and welcoming Muslim community of the 21st century throughout the nation. The approach through a new typology will further allow westerners to shape their own perception of Islam and therefore allow themselves to challenge what they had previously conceived. A new typology will be directly applied at the local level, beginning in the Cedar-Riverside community of Minneapolis, MN, of which has been presented as an ideal site for these ambitions.

In many ways, the problem of American-Muslim misrepresentation began to present itself very clearly while researching sites to host a new form of Islamic Cultural Center. For example: as of fall 2015, the United States reportedly convicted approximately 100 out of 250 individuals that have

identified as having traveled to or attempted to travel abroad to join the Islamic extremist groups.<sup>4</sup> Nearly one quarter of these convicted individuals have come from second and third generation Somali immigrants within the Cedar-Riverside community of Minneapolis, MN.<sup>5</sup> While this seems irregular, it is one of many occurrence happening around the world in which recruitment rates for extremist groups are higher in countries with homogenous cultures.<sup>6</sup> This is true as it becomes increasingly difficult for foreigners to assimilate themselves into a new society that is unaccepting of their culture.

Not only does the Somali Muslim-American population make up a majority of the Cedar-Riverside community, it is also among the largest concentration of 2nd & 3rd generation Somali immigrants in the United States.<sup>7</sup> However, although they are the majority, the Cedar-Riverside Somali community has isolated itself from outsiders and therefore making it

<sup>4</sup> Goldman, Adam. "The Islamic State's suspected inroads into America." The Washington Post. Accessed March 06, 2017. <https://www.washingtonpost.com/graphics/national/isis-suspects/>.

<sup>5</sup> Ibid.

<sup>6</sup> Benmelech, Efraim, and Esteban Klor. "What Explains the Flow of Foreign Fighters to ISIS?" (NBER Working Paper Series, April 2016. doi:10.3386/w22190.): 2.

<sup>7</sup> Mosedale, Mike. "Somali diaspora." Wikipedia. January 07, 2017. Accessed March 06, 2017. [https://en.wikipedia.org/wiki/Somali\\_diaspora#cite\\_note-32](https://en.wikipedia.org/wiki/Somali_diaspora#cite_note-32).

unwelcoming area of the neighborhood for newcomers to explore. Because of this, many of the Somali cultural venues are either left unrecognized or have been tainted in the minds of people as places that service extremists. This situation has called attention to a very serious need for a prominent structure within the Cedar-Riverside community that better represents its large American-Muslim population.



Figure 3.6. Somali community within Cedar-Riverside Neighborhood.



Figure 3.5. Somali venues inside Cedar-Riverside neighborhood.



# United States

Charges by place of residence.

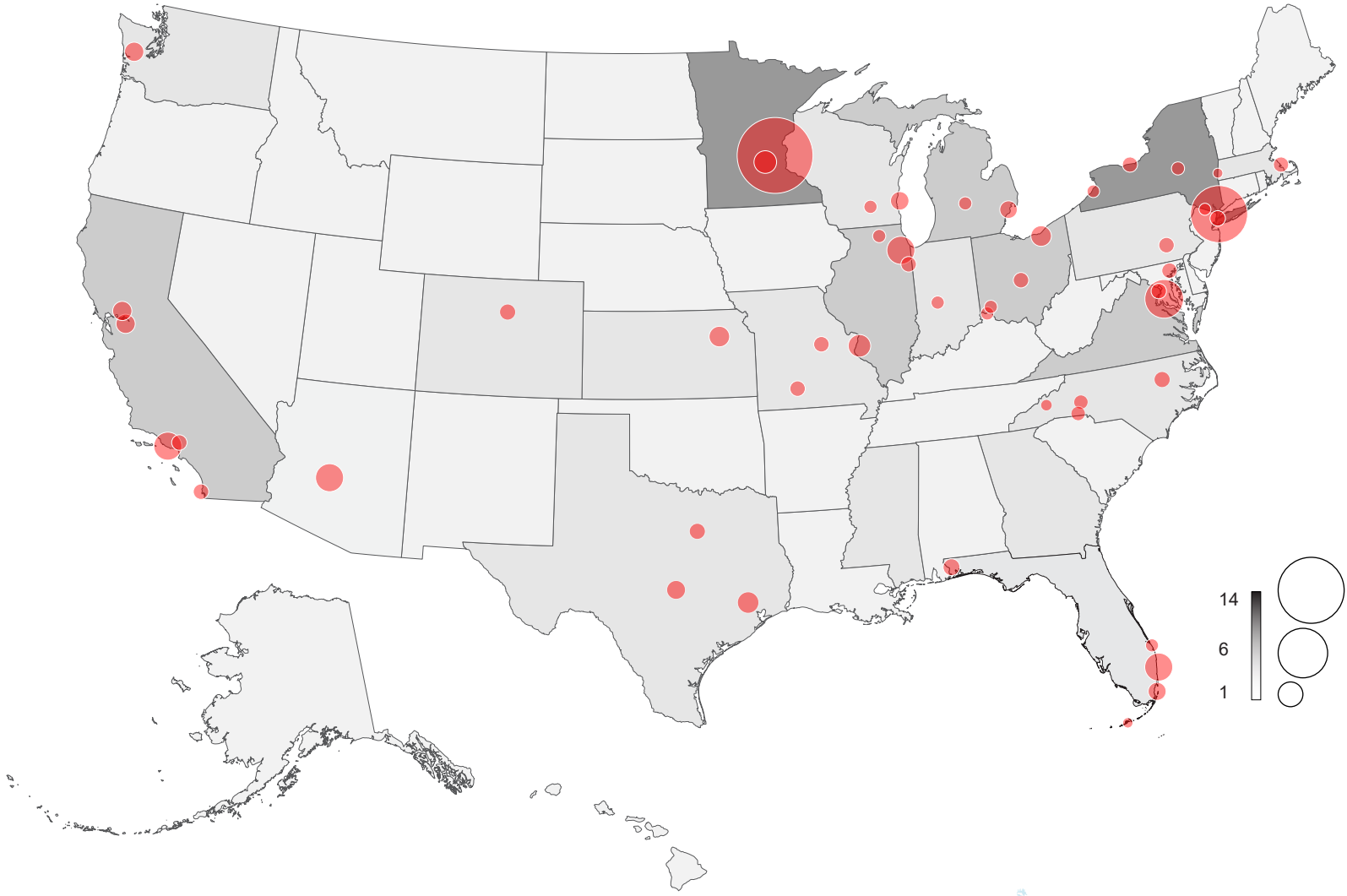

Figure 3.7. Islamist extremist recruitment rates in the United States.

# Minnesota

➤ 4 Pending ➤ 9 Convicted

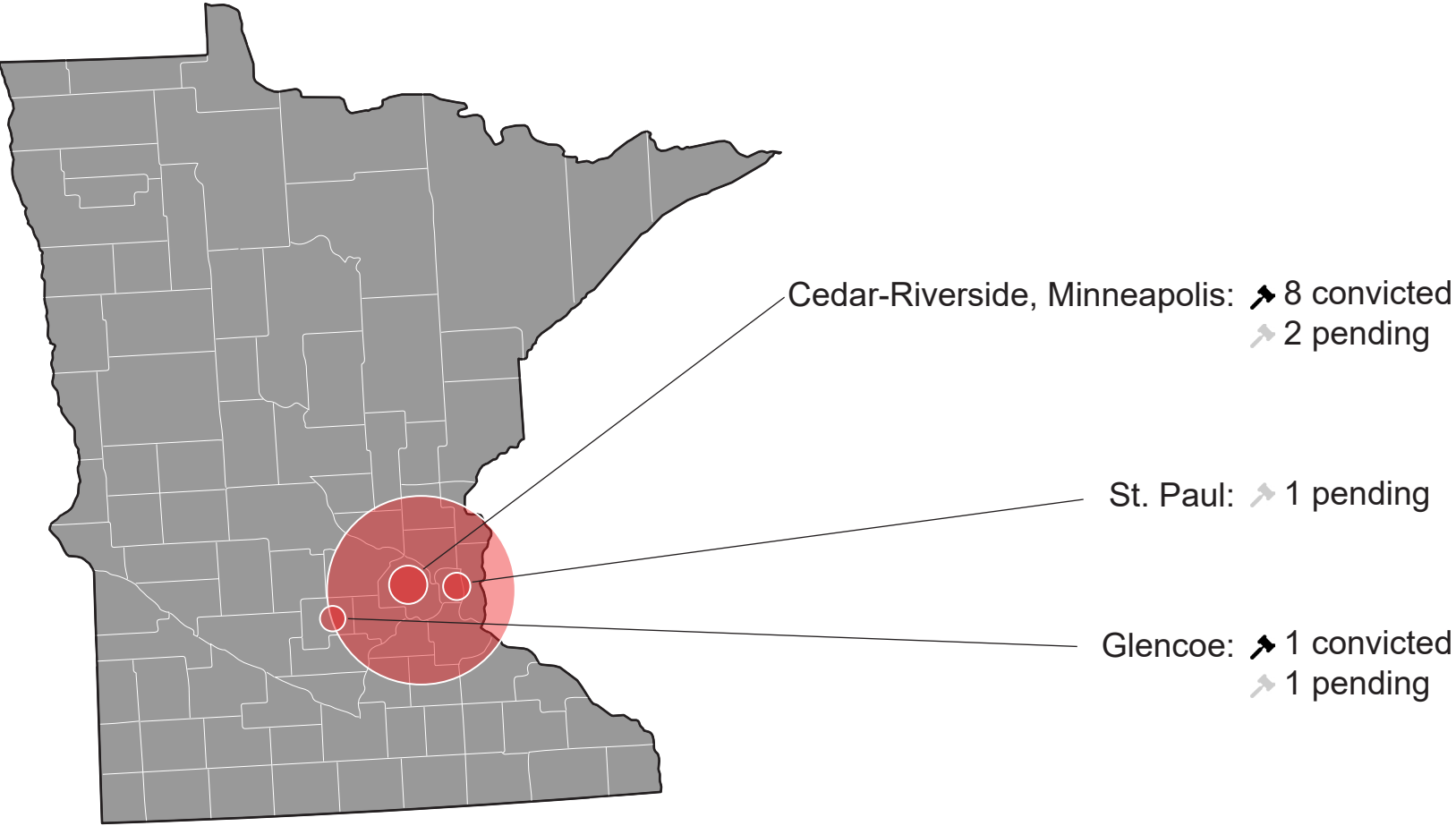

Figure 3.8. Islamist extremist recruitment rates Minnesota.

## Precedent

When developing a program to facilitate the needs of the Cedar-Riverside Somali Community, while also servicing the need to enhance the social and environmental qualities of 21st century Islamic architecture, it is important to reference new and old, successful and non-successful precedents of similar projects. The proposed Islamic Cultural Center for Cedar-Riverside will be comprised of a collection of programmatic elements that primarily service the community's need for worship, cultural education, discussion forums, and recreation space. The organization of the 15th century Islamic Kulliyeh shares an almost identical set of programmatic elements that can be used as an historical reference towards the development of the proposal. In addition to the Islamic Kulliyeh, the proposed Islamic Cultural Center by Buro Koray Duman Architects serves as the contemporary precedent and modern evolution to the historic Kulliyeh complex. While these precedents provide successful examples of Islamic architecture in the new and old world, it is important to examine Jean Nouvel's Arab World Institute in Paris as a failed attempt to

innovate traditional Islamic architecture through the excessive use of motifs and ornament.

First constructed in the Ottoman Empire, the Islamic Kulliyeh is a complex of buildings centered on a mosque and typically composed of a series of annexes. These annexes included and were not limited to a madrasa (school), a Dar al-Shifa (clinic), kitchens, bakery, markets, and baths. The term Kulliyeh is derived from the Arabic word "Kull", meaning "all", and served as a place for the community to fulfill the needs of any household.<sup>8</sup> The organization of this complex is historically important in many ways as it also recalls some of the traditional aesthetic qualities that defined Islamic Architecture. For example, mosques consisted of large grand domes which demanded attention, arched colonnades connected the surrounding buildings that were decorated in ornate motifs, and together all pieces of the complex formed around an inward facing courtyard that was inaccessible for the public. Although the Islamic Kulliyeh acts as a primary historic example with a similar set of programs, the form and aesthetic are obsolete

<sup>8</sup> "Kulliyeh." Wikipedia. March 04, 2017. Accessed March 06, 2017. <https://en.wikipedia.org/wiki/K%C3%BCllyeh>.

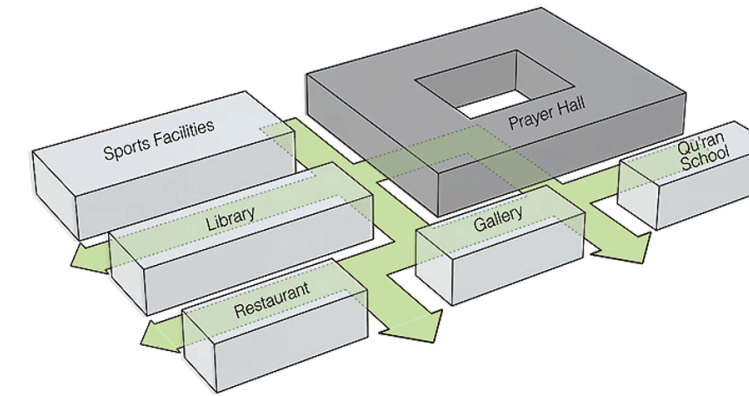

Figure 3.9. Low-slung, horizontal organization of traditional Islamic Kulliyeh - ca. 1500.

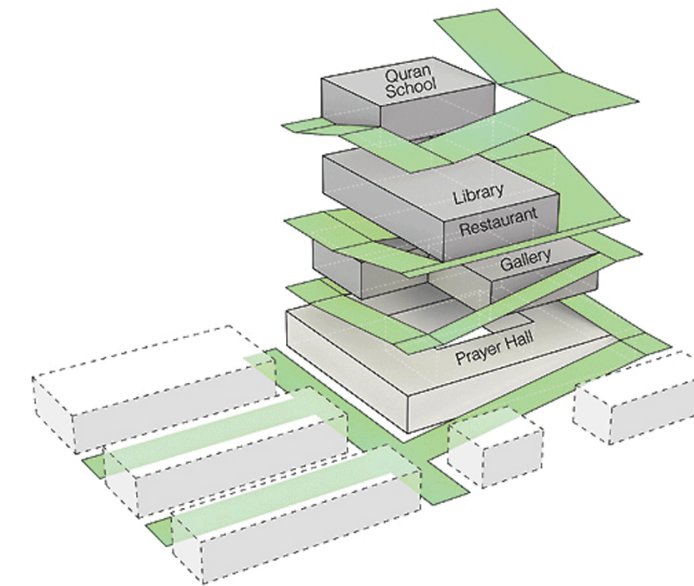

Figure 3.10. Vertical organization of re-imagined Islamic Kulliyeh, BKD Architects - ca. 2016.

towards addressing the problem of embracing a new Islamic architecture.

The contemporary precedent to be referenced is the urban proposal for a new Islamic Cultural Center in NYC proper by Buro Koray Duman Architects. This project is significant because it takes direct cues from the historic Kulliyeh organization but executes the aesthetics in a progressive and alternative way. For example, given the urban context of the proposed center, the architects opted to utilize the formally low-slung, horizontally organized kulliyeh concept but arrange it into a vertical orientation so that the program areas are stacked on top of one another.<sup>9</sup> The central space of the tower would contain an auditorium, a library, a prayer room, restaurants, offices, and other functions that were wrapped with ramps to serve as circulation and public space in place of the traditional courtyard. The tower is clad in glass which makes it transparent, open and inviting and all together "works to replace the image of Islam in the west from one of fear of the unknown to that of something surprisingly pleasant"-Kora Duman firm

<sup>9</sup> McKnight, Jenna. "Koray Duman designs Islamic cultural centre for New York." Dezeen. March 07, 2016. Accessed March 06, 2017. <https://www.dezeen.com/2016/03/02/buro-koray-duman-islamic-cultural-centre-new-york-city-glass-tower/>

cofounder.<sup>10</sup>

Finally, the Arab World Institute located in Paris, designed by the well-known French architect Jean Nouvel, provides an example of traditional ornament misused in contemporary architecture. While the metallic structure of the moving geometric Islamic motifs on the buildings south façade aims to be a contemporary expression of eastern culture, it only continues to associate the building with an “Islamic image” and ultimately begins to fetishize the motif and its symbolism. Furthermore, although the moving motifs serve a dual purpose of performing as a brise-soleil shading device for the interior of the building, they objectively read as a gimmicky architectural applique from the exterior.<sup>11</sup> While using this gesture of alternative Islamic motifs as a poor example, it is important to consider how the richly symbolic motif can be embodied into contemporary Islamic architecture in a more successful and less obvious way.

Through the research of religious Islamic architecture, it is evident that the Mosque and its supporting structures

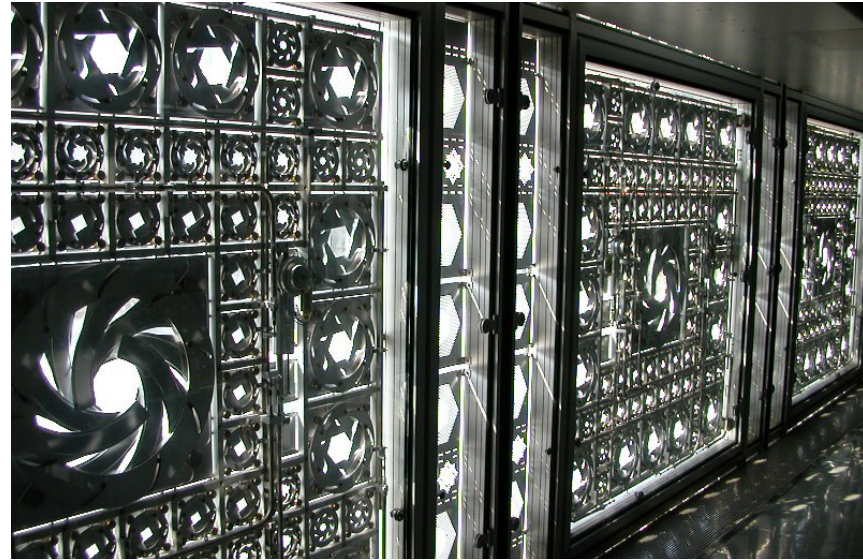

Figure 3.11. Jean Nouvel - Arab World Institute facade detail, Paris FR.

have become a prominent symbol for Islam and Muslims alike. While historical examples such as the Kulliye garner large importance it does not tell the rich and diverse story of Muslim Americans in the 21st century. The urban example from Buro Koray Duman Architects moves in the direction that fulfills the need to explore new forms of Islamic architecture with stylistic and programmatic diversity that better accommodates the Muslim American community today. This thesis project proposal aims to embody the multi-faceted qualities explored in the contemporary example, and expand upon them in a unique way.

<sup>10</sup> Ibid.

<sup>11</sup> Asensio, Paco. *Jean Nouvel*. (New York: TeNeues Publishing Company, 2002.): 8.

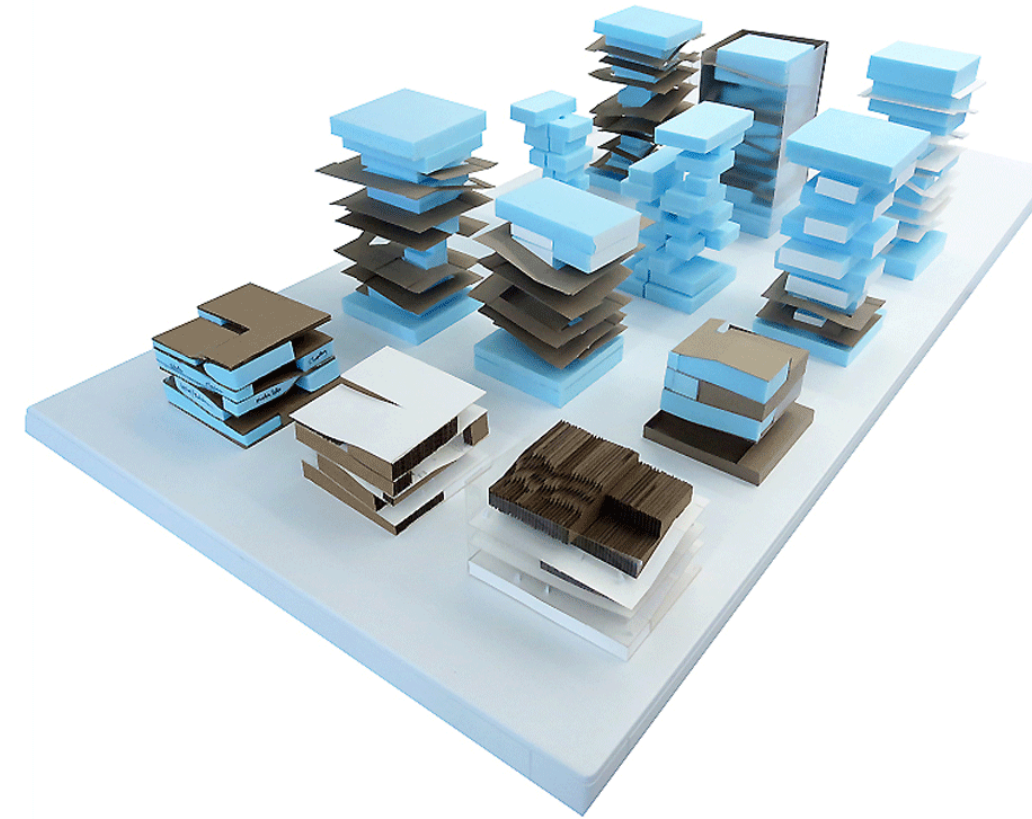
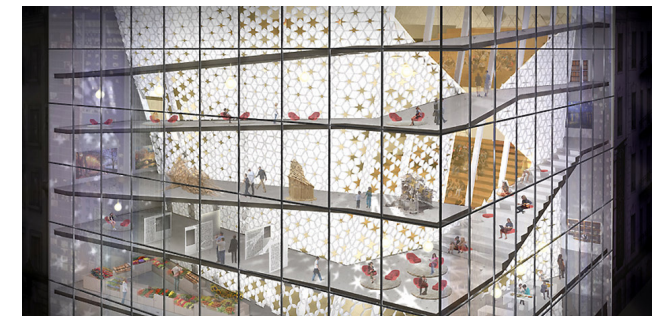

Figure 3.12. Left: BKD Architects stacked Islamic Kulliye concept models.  
Figure 3.13. Right: Islamic Cultural Center by BKD Architects - New York City, NY.





## Literature

Throughout the development of contemporary Islamic architecture, there have been several prominent authors that have contributed to the discourse and movements of the period. Together, they have a diverse set of backgrounds that range from historians to practicing architects and ultimately provide a thorough examination of the work at hand. The information they have gathered and disseminated is rooted in history, beginning with traditional Islamic architecture and Mosque design, and continues to critic contemporary works of Islamic architecture in the 21st century throughout the west. This chapter will elaborate on the key works of literature that were pivotal to the growth and on-going exploration of this thesis towards a new Islamic architectural typology.

To begin, George Michell from *Architecture of the Islamic World* states that, "Architecture is more than a history of form and style: it is a product of cultural and environmental factors and an expression of the way of life of the people for whom it is built."<sup>12</sup> This quote, and the entirety of the book were influential

when recognizing the historical and cultural significance Islamic architecture inherently embodies. It covers, at length, architecture and society, as well as many key monuments of Islamic architecture throughout the Middle-East and other predominantly Muslim countries. Along with this book, *Earthly beauty, heavenly art - Art of Islam* by Mikhail B. Piotrovsky was another integral resource of information towards understanding the rich history of traditional Islamic art. It covers the importance of Islamic art for everyday life, the language of Islamic art and the symbolism embedded within its motifs.

During the research process there proved to be several useful resources with examples and practices of contemporary Islamic architecture. However, the two books: *The Mosque and the Modern World* by Renata Holod and *Deconstructing the American Mosque* by Akel Kahera stood-out as the most fruitful within this genre. In addition to these, the online article "Why Islamic Architecture in the United States is Failing American Muslims"<sup>13</sup> by Jenine Kotob played a key role in learning how to define and critically analyze what contemporary Islamic

<sup>13</sup> Kotob, Jenine . "Why Islamic Architecture in the United States is Failing American Muslims." ArchDaily. July 21, 2016. Accessed March 14, 2017. <http://www.archdaily.com/791724/why-islamic-architecture-in-the-united-states-is-failing-american-muslims>.

architecture means to the west, specifically America, and how it can best represent a more progressive American-Muslim population. Jenine questions, "How can architects go about designing [Islamic architecture] that is relevant, responsive, inclusive and more importantly, actively constructive for an American audience?" It is questions like these, among others, that this thesis aims to break down and help answer through the iterative process of research and design.

**“Architecture is more than a history of form and style: it is a product of cultural and environmental factors and an expression of the way of life of the people for whom it is built.”** - George Mitchell



Figure 3.14. American-Muslim female in U.S. flag hijab.

<sup>12</sup> Michell, *Architecture of the Islamic World*, 7



Figure 4.1. View inside mosque of proposed cultural center.

## PROJECT

### CEDAR-RIVERSIDE MOSQUE & ISLAMIC CULTURAL CENTER

#### Site

The site for the proposed Islamic Cultural Center within the Cedar-Riverside neighborhood is ideal for it becoming a prominent symbol of the community. While choosing a site it was important to consider factors, such as: proximity to other Somali/Muslim venues, ease of accessibility through available modes of public and private transportation, zoning, etc. However, the most important factor to consider was the necessity for a prominent street-front presence. This was imperative as one of the main goals the proposed center aims to achieve is to bring awareness to Islam and better represent a modern American-Muslim community. With this site location, the new Islamic Cultural center is able to become a landmark within the neighborhood and therefore allow visitors to associate Cedar-Riverside in a more positive way.

Although Cedar-Riverside aspires to grow and continue developing, there are only a handful of vacant lots available for new construction. With limited options, the site chosen for the center is a series of parcels for sale that form a distinct triangular shape. Not only is the site's shape unique, but

in addition to it facing a main street, it forms an island with roads circling all three sides. The triangular-island is situated on a very prominent corner of the main street, Riverside Avenue, and is passed frequently due to its direct access into downtown Minneapolis. Because of this, a building on this site exceeding two stories is able to be seen from the periphery of downtown and can add to the skyline of the Cedar-Riverside neighborhood.

Not only does the site have optimal exposure along a major street, it is also uniquely positioned between two zones (residential and commercial) and therefore belongs to a specific category of commercial zoning.<sup>14</sup> This is significant because the context and building typologies surrounding the site differ dramatically. On one side the site faces a large Minnesota University building with an attached park, on each corner the site is bookended by two-story retail venues (of which include and African Heritage Center), and directly behind the site is a complex of 2-3 story apartments for single/multi-family homes. This mix of typology presents the challenge to enhance and unite the social and architectural context of the neighborhood.

<sup>14</sup> "Zoning Maps." City of Minneapolis. May 7, 2014. Accessed March 07, 2017. [http://www.minneapolismn.gov/zoningmaps/zoning\\_maps\\_index](http://www.minneapolismn.gov/zoningmaps/zoning_maps_index).

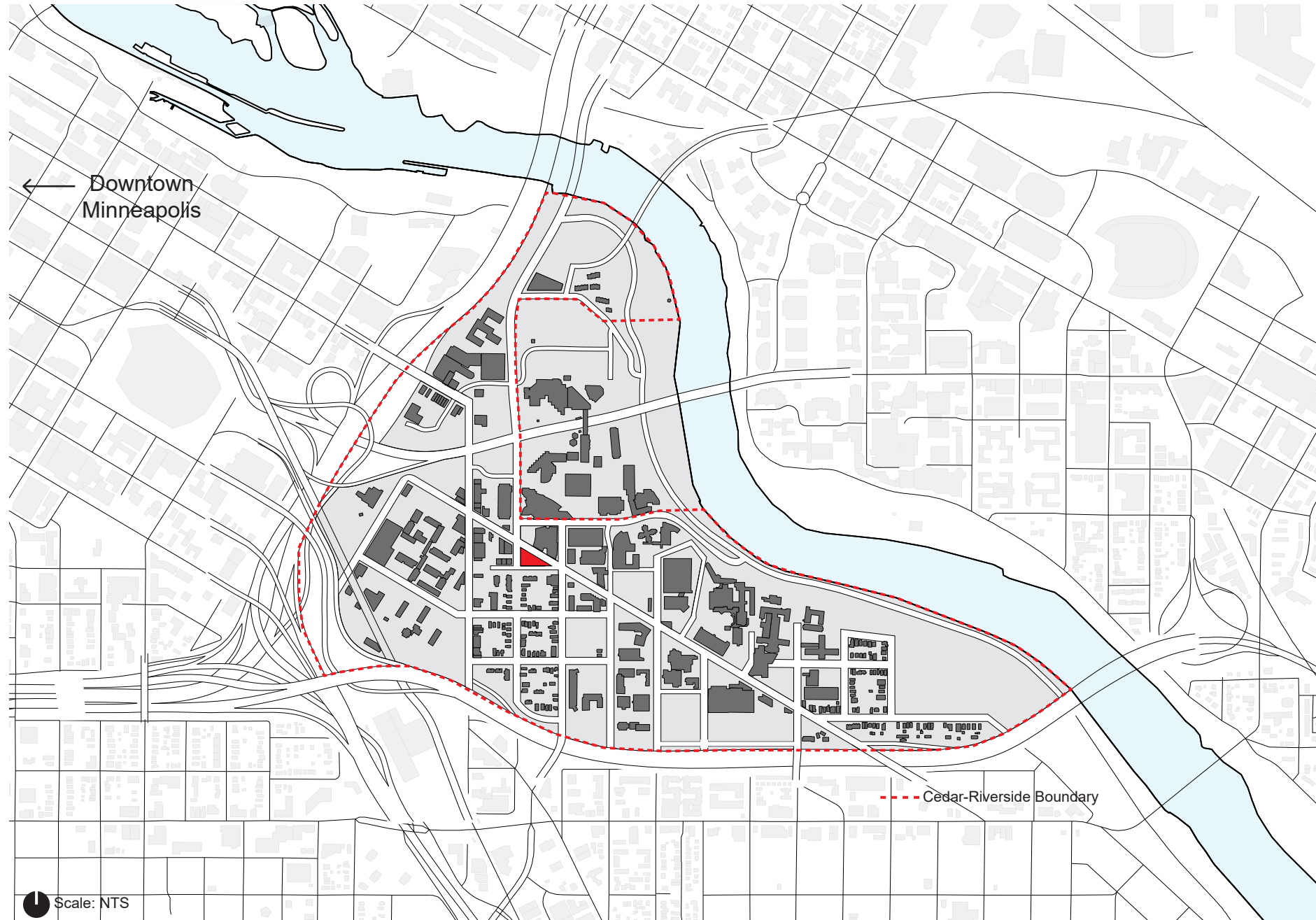

### Zoning

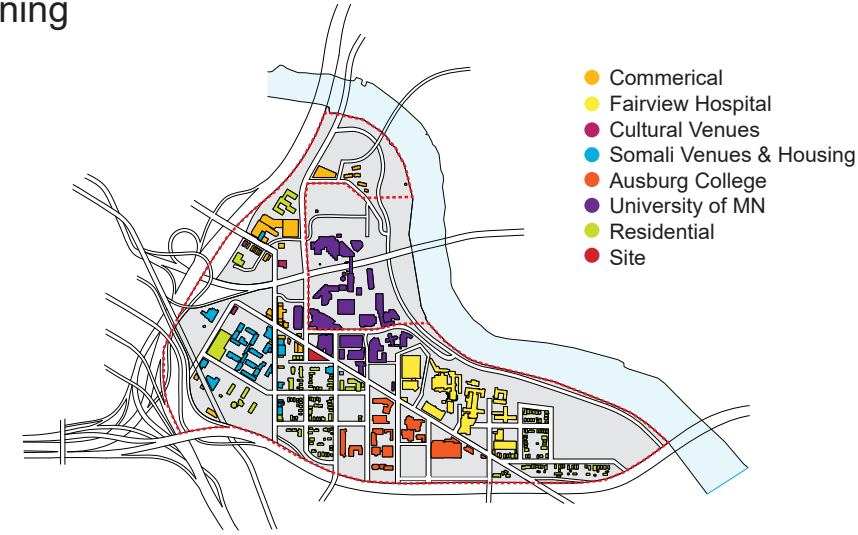

### Parks

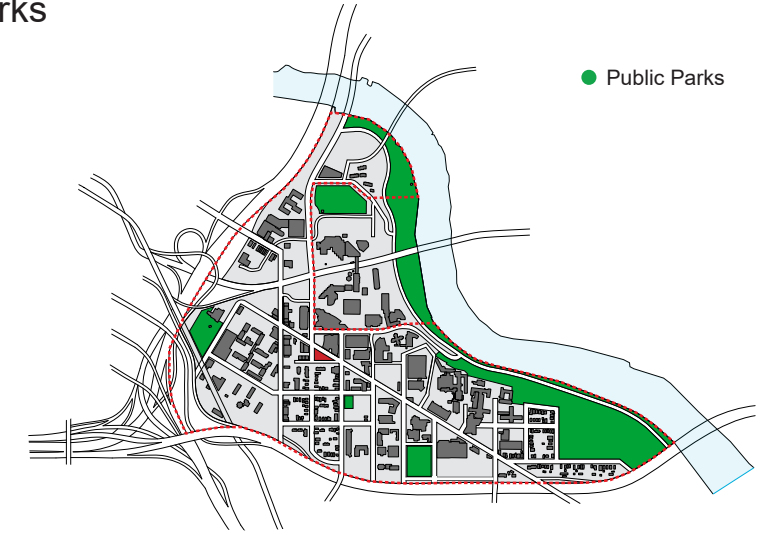

### Transportation

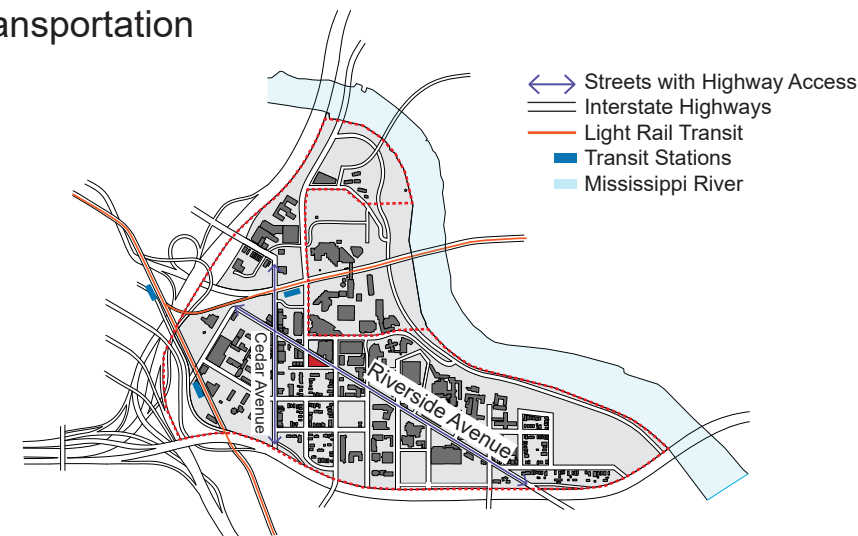

### Walking Radius

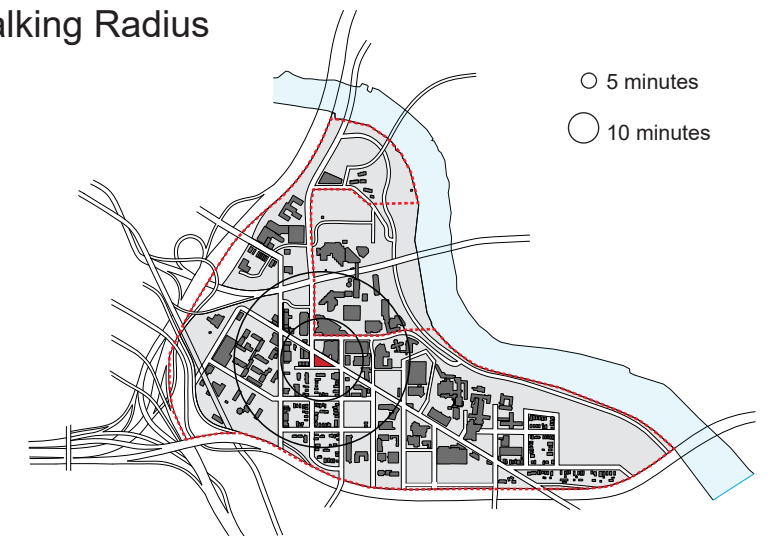

Figure 4.2. (Opposite) Cedar-Riverside neighborhood within context of Minneapolis.  
 Figure 4.3. Diagram compilation of Cedar-Riverside site analysis.

## Program

Developing the program for the proposed Cedar-Riverside Islamic Cultural Center began as a concentrated effort to provide a place of sanctuary for the local Somali's, and expanded outward to include elements for the convergence of the entire community's social make-up. This approach is how the center evolved into becoming a place that included several layers of out-reach and services that could successfully cater to a larger and more diverse group of people inside and outside of Cedar-Riverside. This chapter will break down the conception of the center's programmatic elements that work to achieve the objectives of the project, and how they are capable of influencing change on the local and national scale.

To begin, initial steps were taken to rectify the local phenomenon of young Somali recruitments in Cedar-Riverside for Islamist extremist groups abroad. For example, as mentioned earlier, the Cedar-Riverside community is home to nearly one quarter of the country's convicted individuals that have joined or have attempted to join Islamist Extremist groups since fall of 2015.<sup>15</sup> This phenomenon is not restricted

to the United States and has occurred in other countries throughout the world. However, unlike the United States, a selection of other countries has put in place programs to prevent radicalization and deradicalize individuals that were involved in terrorist-related activities that are similar to those which occurred out of Cedar-Riverside. These programs are highly specific to the social and cultural characteristics of the place in which they are implemented, and therefore should not be transplanted from one country to another. However, by identifying some of the best practices, the United States can begin to incorporate the successful elements of out-reach, education, and prevention into new cultural projects.

The results of the programs analyzed have important implications towards the development of a US program. For example, lessons can be learned from the programs in some of the Western and European countries and some of the Middle Eastern countries that share secular political institutions, liberal values and have an openly democratic approach towards prevention and deradicalization of individuals.<sup>16</sup> Because the

<sup>16</sup> Rabasca, Angel, Stacie Pettyjohn, Jeremy Ghez, and Christopher Boucek. "Deradicalizing Islamist Extremists." Report. RAND Corporation. 2010. [http://www.rand.org/content/dam/rand/pubs/monographs/2010/RAND\\_MG1053.sum.pdf](http://www.rand.org/content/dam/rand/pubs/monographs/2010/RAND_MG1053.sum.pdf) (Accessed October 2016): 190

United States does not already have a domestic counter-radicalization strategy, it is best to start at the local level and leverage the local entities that could be used to achieve these objectives. It is also important to note that while many Western and European countries do not recognize ideologies based on religion, religious dialogue and debate should be considered and encouraged in US programs because of the central role religion plays in the motives of Islamic extremists.

In conclusion to these facts, the proposed Cedar-Riverside Islamic Cultural Center will include a multi-faceted program to host the individual elements needed towards providing for the community. For example, the center will include a mosque to be used as a place for group and individual worship, a resource center for religious and cultural texts with classrooms for counseling and discussions, a public gallery with rotating exhibitions pertaining to Islamic/Somali art and culture, and place for leisure such as a restaurant or café. In addition to these enclosed spaces, there will be an abundance of outdoor green space that is accessible by all from the exterior. This green space will also be visible from the interior, therefore creating the feeling of being surrounded by nature even within

the dense urban environment. Together, these individual program elements work to facilitate the needs of local Somali American-Muslim community, while also including elements that are accessible and embracing to all members of the community - Muslim and Non-Muslim. By doing this, the center goes beyond making an impact on merely the local scale and can create influence nation-wide.

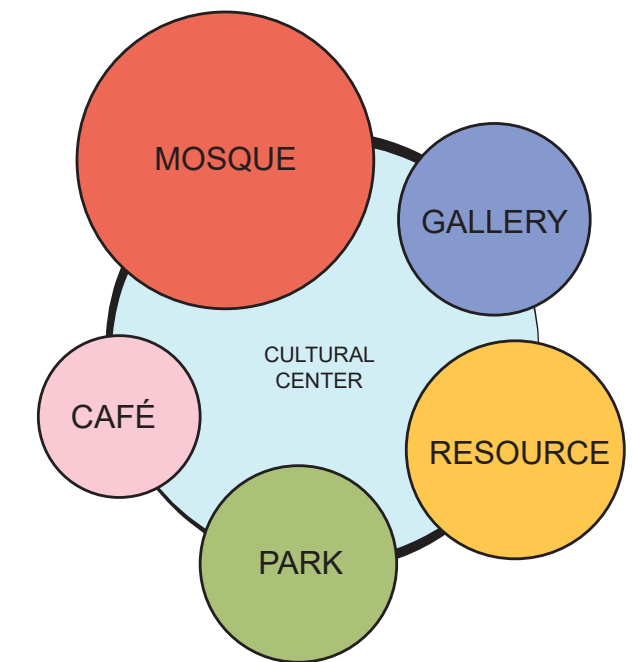

Figure 4.4. Preliminary program diagram.

<sup>15</sup> Goldman, "The Islamic State's suspected inroads into America."

## Design Guidelines

Design guidelines for the proposed Islamic Cultural center are important to establish in order to successfully meet the standards of a new 21st century Islamic architectural typology. Not only do these guidelines aim to influence trends throughout the nation, but they will inevitably have a lasting effect on the social and environmental factors of the local community. Important factors to consider while constructing the design guidelines include: arrangement of program, use of materials, sustainable features, environmental context, and public/private access. By abiding to the details of these guidelines, the center can develop harmoniously and cohesively while combining elements of the old with the new.

When arranging the diverse set of program elements, this project will quote the form and stacked organization of the historic Islamic Kulliye that is seen in the BKD Architects example. By stacking the program vertically it creates ease of access and circulation for users, while also utilizing a majority of the site for public green-space. This is notable because the vertical arrangement explores a new form of Islamic architecture and accommodates the need for access to the environment that is required in Islam. In

fact, it states in the Quran that there is no prescribed architectural form for worship space, and instead there is to be complete flexibility, openness, and pragmatism in mosque/sacred architecture construction. The only thing that is stated is the environmental context of Muslim worship, and that the connection between the human body and nature is essential to Islamic Architecture.<sup>17</sup>

Material selection is another highly important factor to consider when establishing design guidelines. As stated in earlier sections, the proposed Islamic Cultural Center aims to be outward looking, transparent and embracing to all members of the community. This is achievable through the use of materials that allow outsiders to see into the center for a full disclosure of the activities taking place inside. By doing this, outsiders are better able to immediately dispel any fear-based attitudes towards the Islamic faith and may even be inspired by the curiosity to know more. The use of transparent materials not only allows the center to be open and welcoming, but is also a material that is relevant to contemporary design and advancements in building technology.

<sup>17</sup> Kahera, Akeel Ismail. *Deconstructing the American mosque: space, gender, and aesthetics*. (Austin: University Of Texas Press, 2008): 36-37.

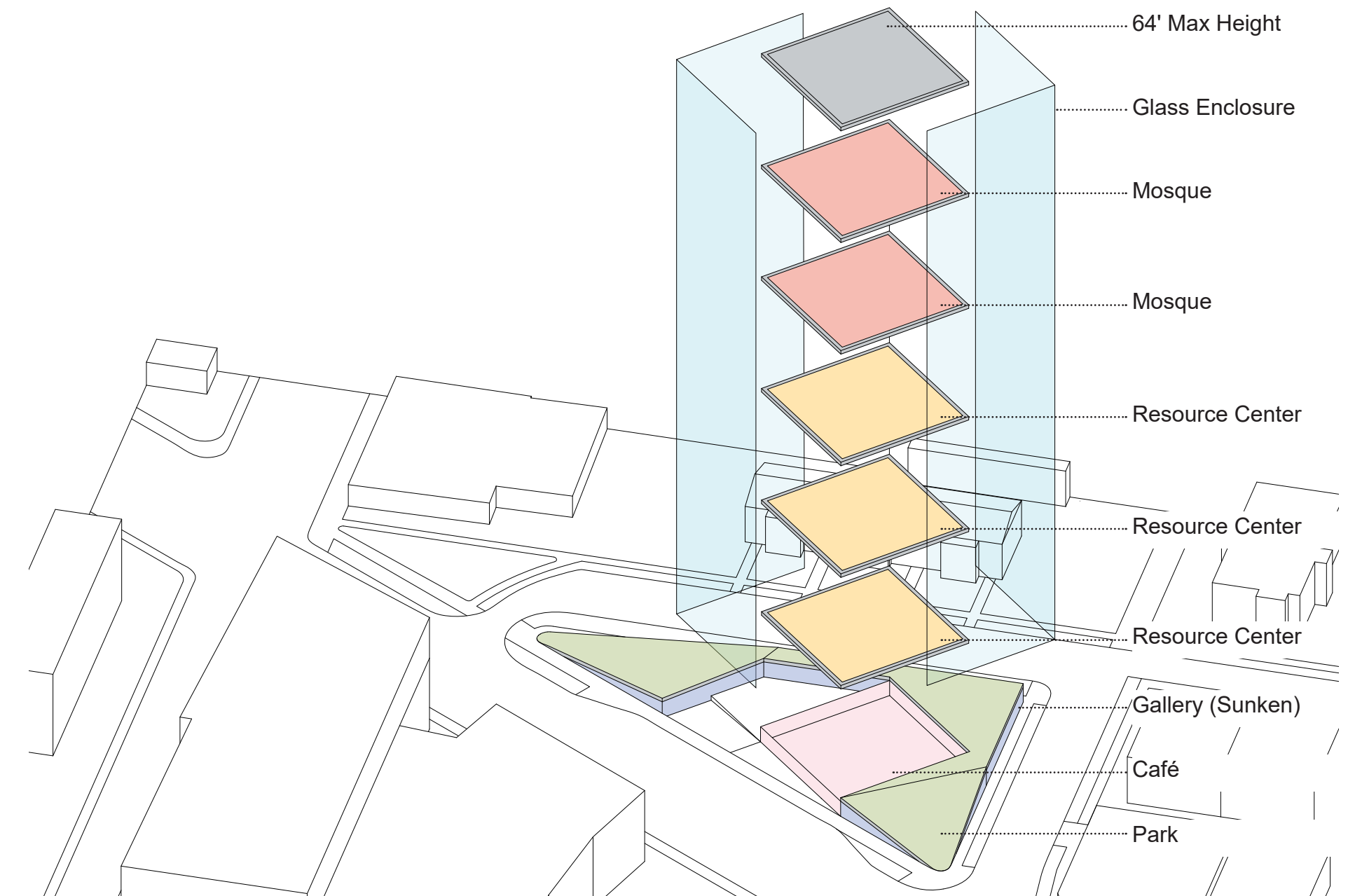

Figure 4.5. Preliminary program arrangement on-site.

## Outcome

The design outcome of the proposed Cedar-Riverside Islamic Cultural Center will embody the necessary and significant elements gathered throughout the course of research in all the previous sections. It will become a compilation of parts that each strives to serve the specific needs of the local community, the quest for a new Islamic architectural typology, and to enlighten western society on Islam and the American-Muslim community. Because it is grounded in scholarly research and quotes historical and contemporary references, it's design qualities are not arbitrary and warrant merit overall. This chapter will conclude the final design decisions of the Cedar-Riverside center and elaborate on their significance within the discourse.

As discussed in the previous section on design-guidelines, the center will be composed vertically and take the form of a mid-rise tower that is oriented towards the direction Islam's holy site, Mecca.<sup>18</sup> The tower will rest on a podium that houses the centers most public program elements and will be equipped with green roofs and other sustainable features.

Within the podium and under the green roofs will be a sunken museum and gallery space that is easily accessible from the street and will be dedicated to the rotating exhibits of Islamic/Somali art and culture. At the very base of the tower, and on the street level, will be a café & restaurant that specializes in Middle Eastern cuisine, and will also contain the main lobby entry to the upper levels within the mid-rise tower.

Ascending the tower from the base will be the remaining parts of the program that are most publicly accessed, and terminating with the most private. For example, situated directly above the base will be three levels of multi-media resource centers that are equipped with archives and texts of Islamic culture/religion as well as meeting rooms for group and independent study. These levels will adopt an open floor plan that house movable furniture and folding partitions between spaces to minimize the amount of dedicated private space and allow the freedom of complete flexibility for the users' needs over time. Located above the multi-media resource levels will be a community Mosque designed to facilitate approximately 200 members for either group or individual worship. The mosque will be double height and occupy the top two levels

of the mid-rise tower, along with the necessary administrative and ablution space needed for worship. The placement of the mosque allows for direct lighting from the sky above while also fulfilling the necessity of the worshipper's connection to the environmental context.

Because the mid-rise tower is taller than many of the structures in its' surroundings, it is important to massage its form into the context of the neighborhood. The proposed mid-rise will be situated on the northwest corner of the site to capture sight vantage points and to help generate the density needed to create an urban corridor down Riverside Avenue. This placement also allows the remaining site property to be utilized for the open park space that is lacking throughout Cedar-Riverside. Ideally, the park space would consist of the podiums green roofs that gently slope down towards the prominent corners of the site for accessibility from the street level. Finally, the building will be free of any ornament suggesting the "Islamic image" and instead will embody the traditional Islamic motif spatially. These dynamic spaces will be arranged on the perimeter of the building and enclosed within a transparent skin, which further encourages a new

outward looking architecture to dispel issues of trust and safety facing the Muslim community today. It is through such new exploration of form, material, and environmental context that the proposed Cedar-Riverside Islamic Cultural Center can begin to achieve its goals of representing the hallmarks of a truly benevolent society.

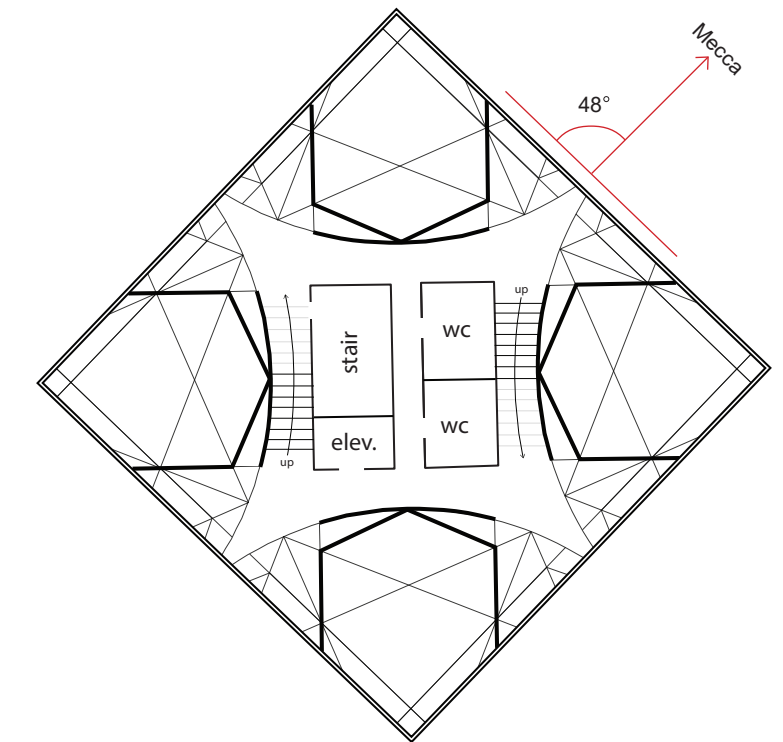
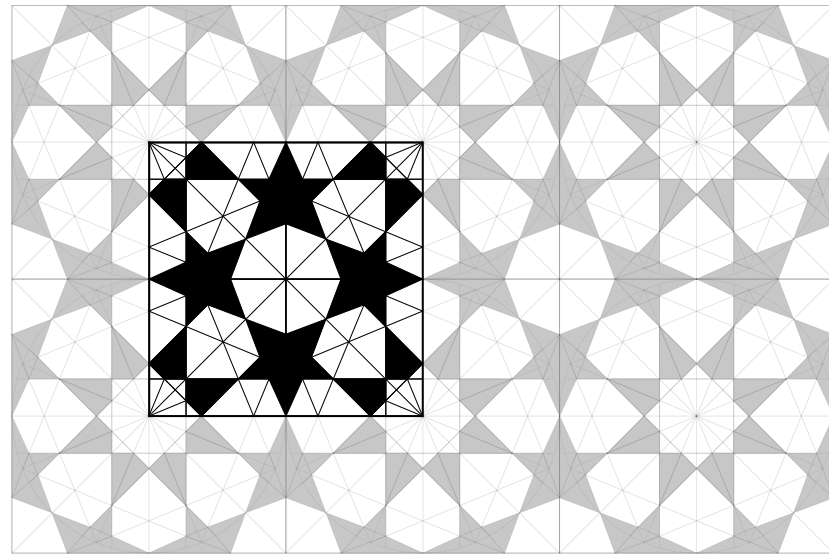
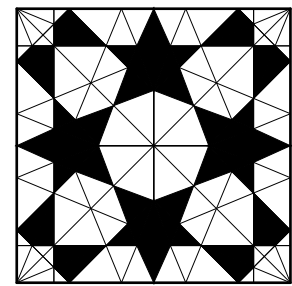

Figure 4.6. Conceptual floor plan diagram - Islamic motif becomes spatial.

<sup>18</sup> Michell, *Architecture of the Islamic World*, 16.



The convergence point of four Islamic patternmaking-tiles reveals a promising form.



Fixed pattern

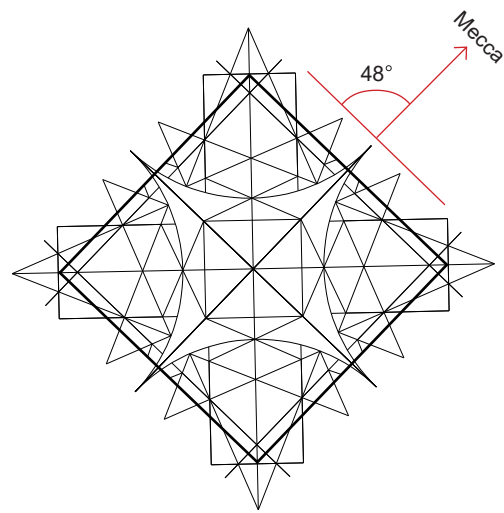

Rotate and Scale

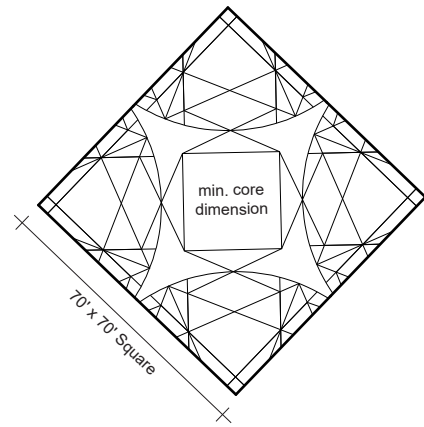

Crop to Fit

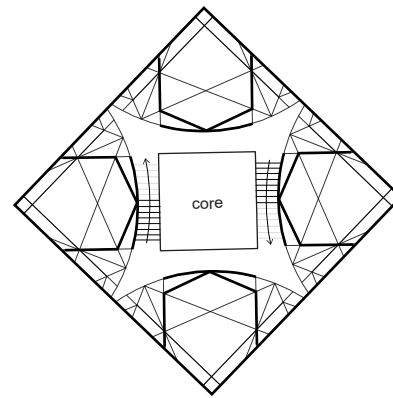

Demarcate Space + Circulation

Figure 4.7. Evolution of typical floor plan inspired from Islamic patternmaking.

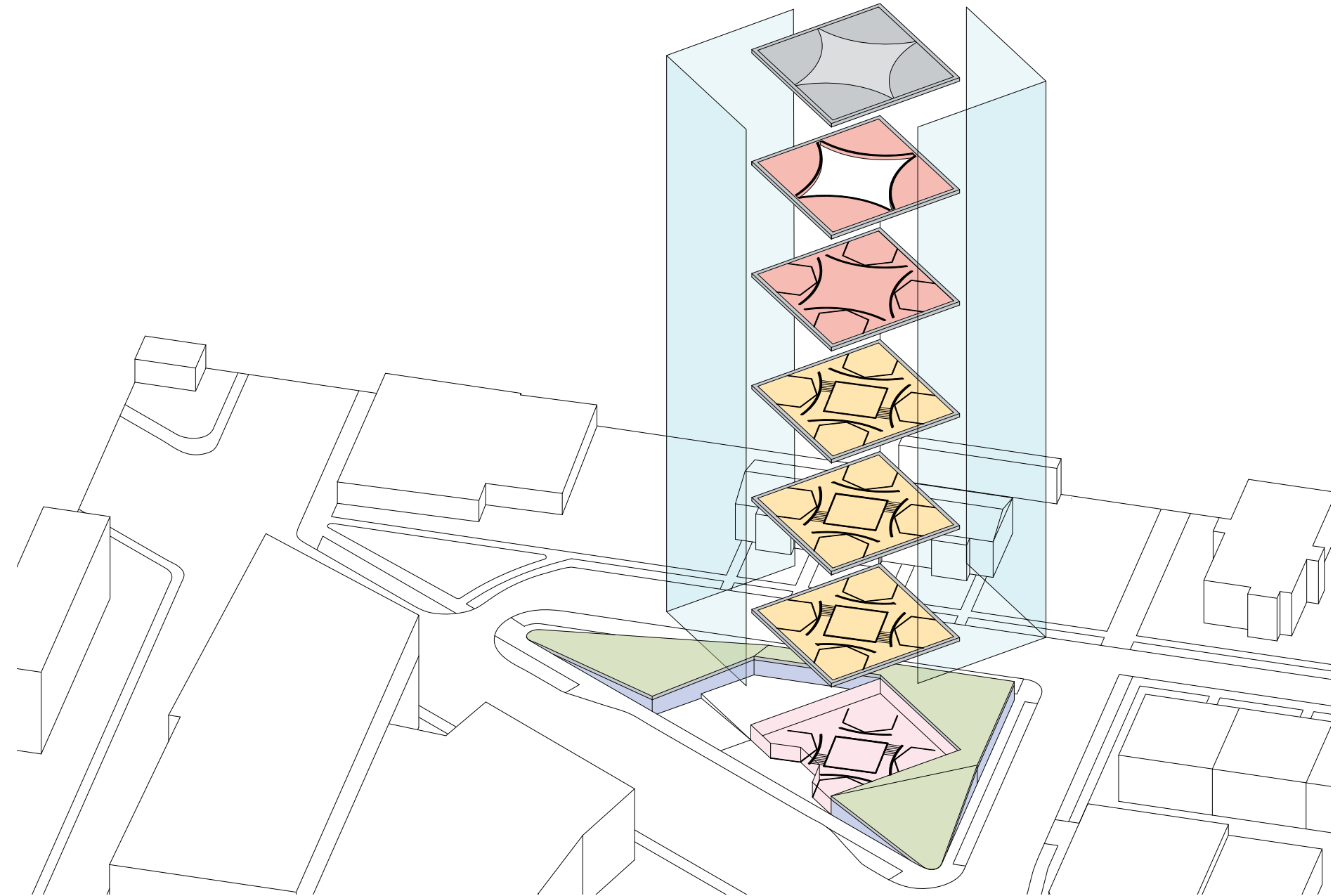

Figure 4.8. Preliminary interiors arranged by level.

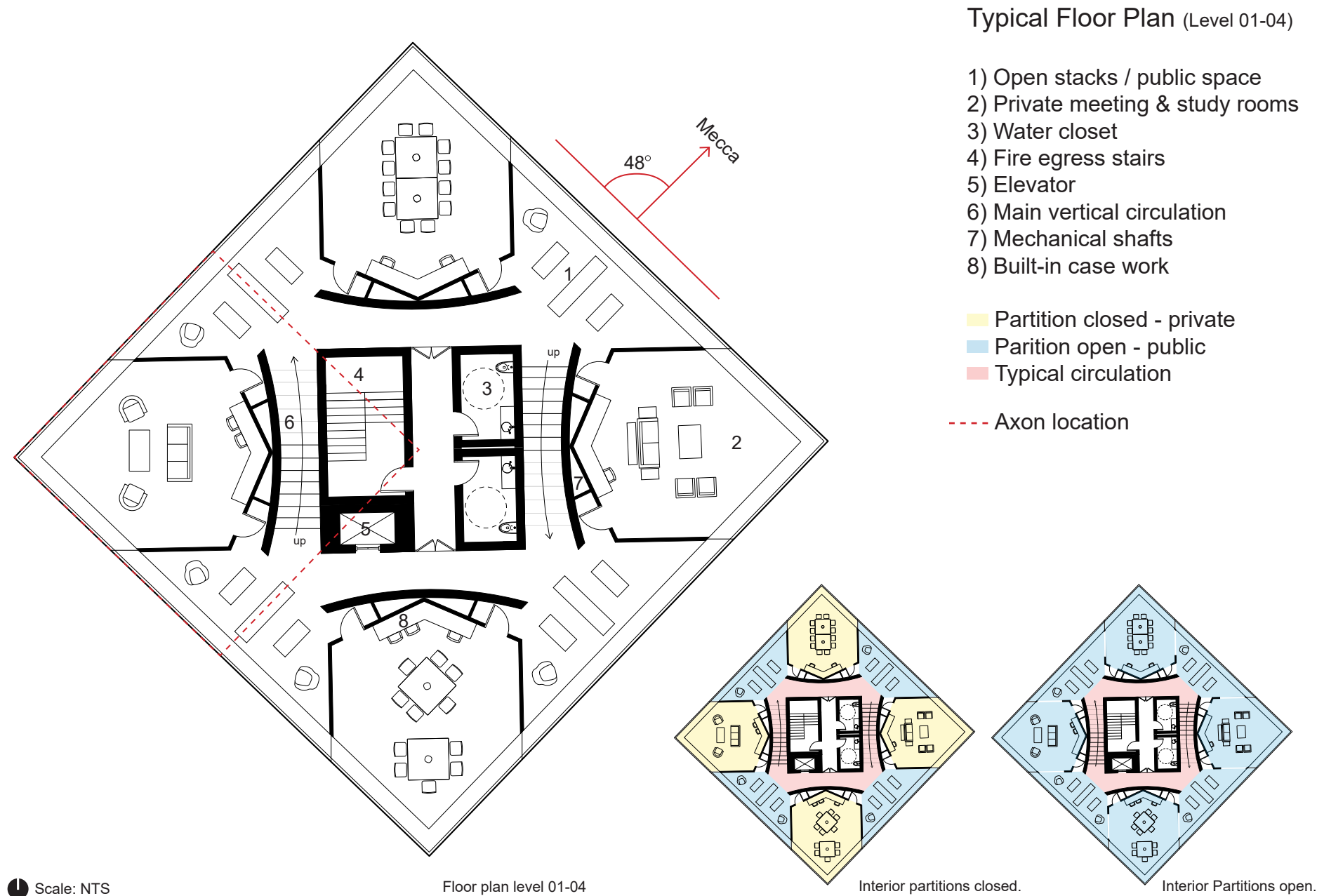

Figure 4.9. Typical floor plan - resource levels.

### Axonometric Section

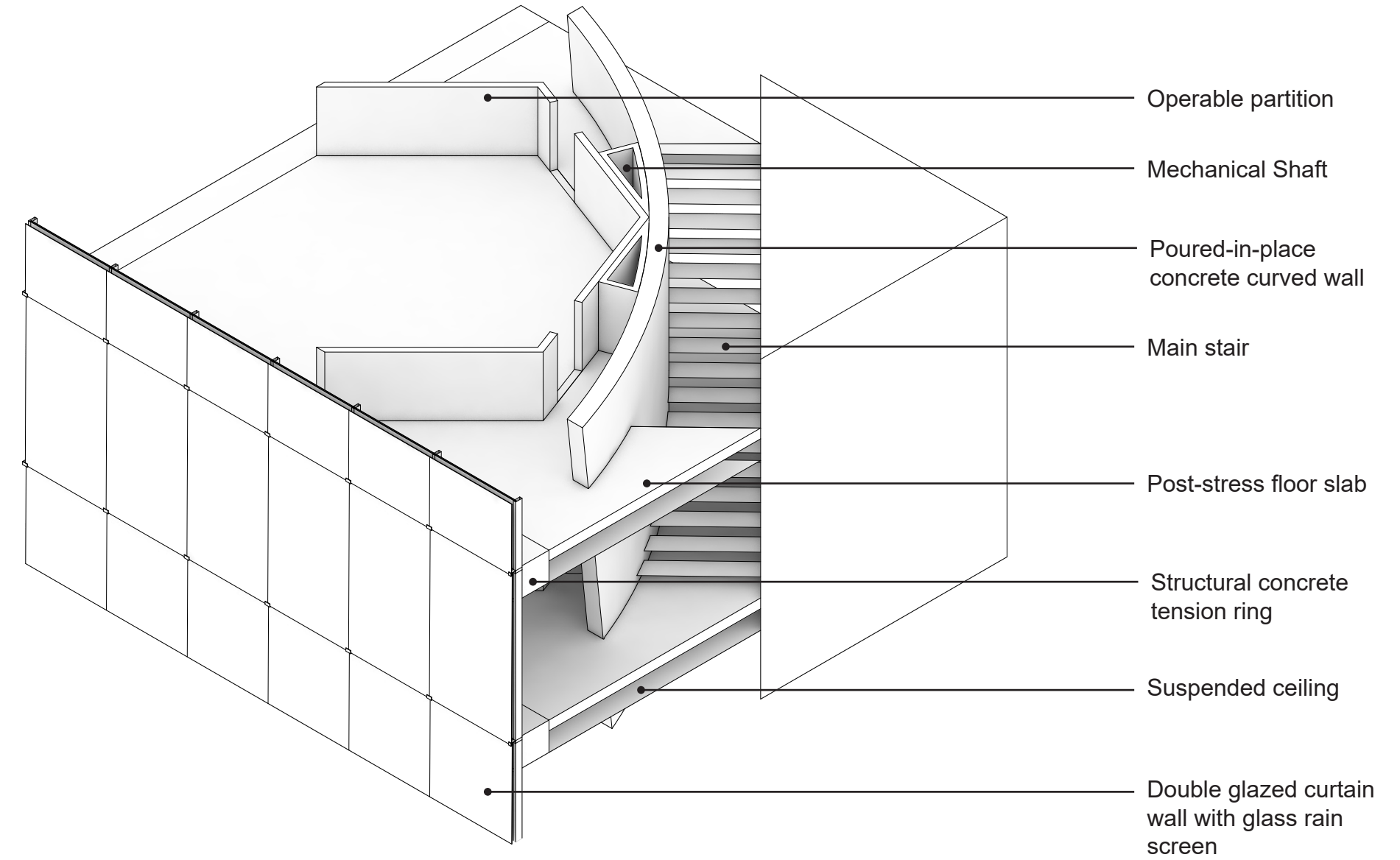
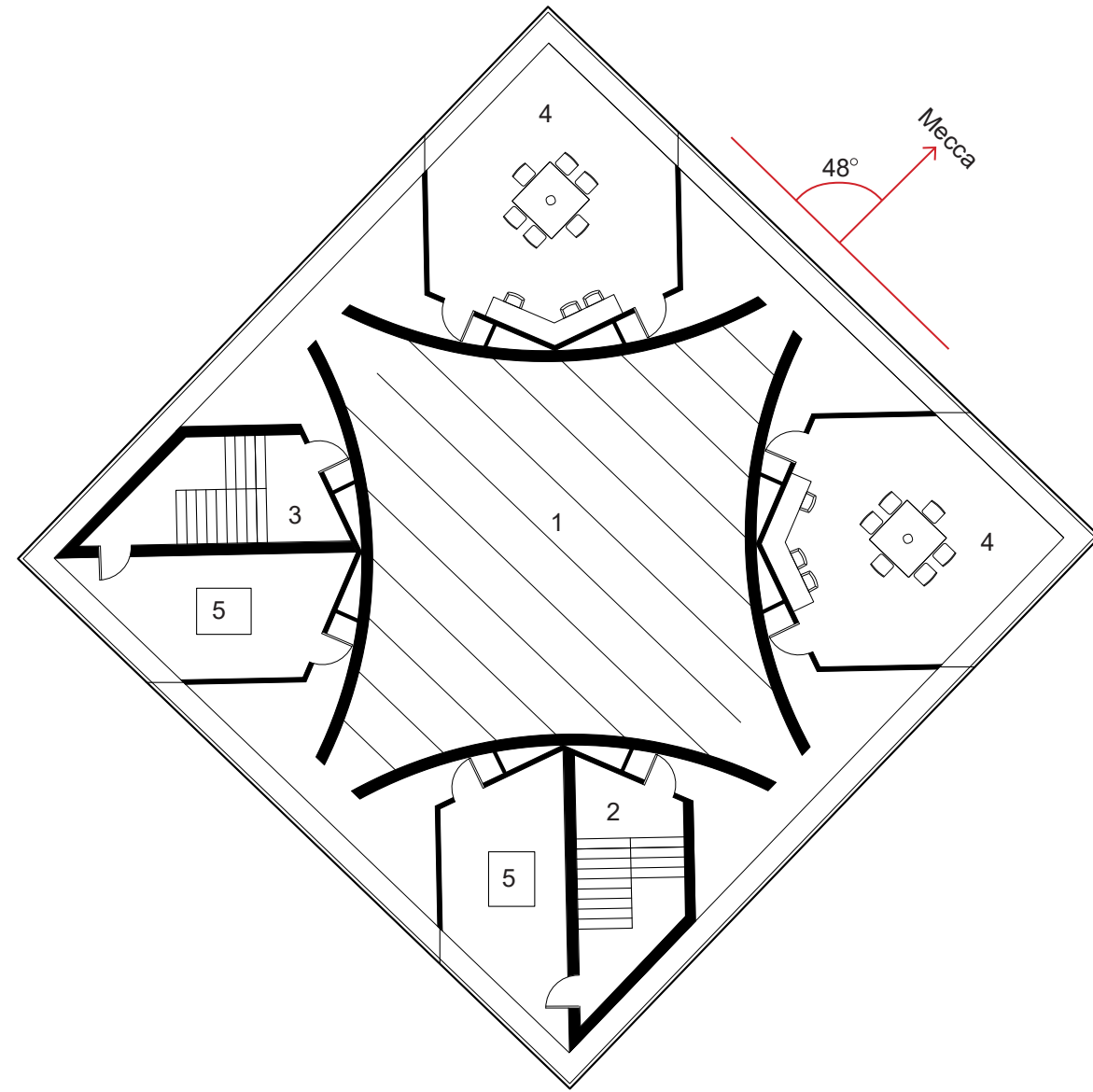

Figure 4.10. Axonometric section with construction assembly call-outs.





Mosque Floor Plan (Level 05)

- 1) Main prayer hall
- 2) Optional women's stair entry
- 3) Optional men's stair entry
- 4) Imam offices + administration
- 5) Ablution

■ Location of mosque within structure

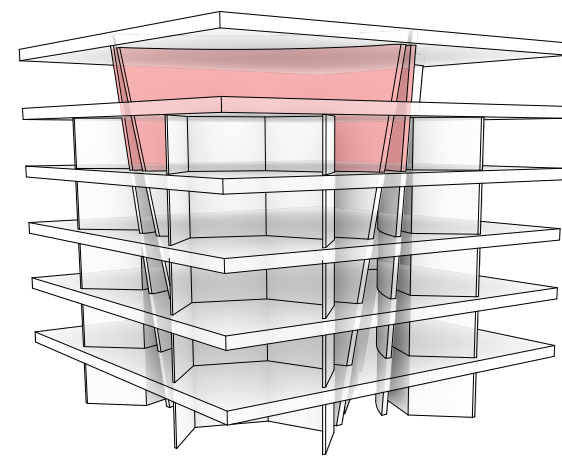

Figure 4.11. Typical floor plan - mosque level.



Figure 4.12. View of Mosque interior facing Mecca. Concrete curved walls become increasingly more textured to suggest the direction of prayer.



Figure 4.13. Sketch rendering from North-West corner of the site.



Figure 4.14. Sketch rendering from green roof / elevated park.

## Bibliography

- Asensio, Paco. *Jean Nouvel*. (New York: TeNeues Publishing Company, 2002.): 8.
- Benmelech, Efraim, and Esteban Klor. "What Explains the Flow of Foreign Fighters to ISIS?" (NBER Working Paper Series, April 2016. doi:10.3386/w22190.): 2.
- Fairs, Marcus. "Museum of Islamic Art." Digital image. Dezeen. December 2, 2008. Accessed March 6, 2017. <https://www.dezeen.com/2008/12/02/museum-of-islamic-art-by-im-pei/>.
- Florida, Richard. "Why So Many Foreign Fighters Flock to ISIS." Defense One. August 10, 2016. Accessed March 06, 2017. <http://www.defenseone.com/ideas/2016/08/geography-foreign-isis-fighters/130640/>.
- Goldman, Adam. "The Islamic State's suspected inroads into America." The Washington Post. February 22, 2017. Accessed March 06, 2017. <https://www.washingtonpost.com/graphics/national/isis-suspects/>.
- Holod, Renata, and Hasan-Uddin Khan. *The mosque and the modern world: architects, patrons and designs since the 1950s*. (London: Thames and Hudson, 1997.): 13
- Kahera, Akel Ismail. *Deconstructing the American mosque: space, gender, and aesthetics*. (Austin: University Of Texas Press, 2008.): 36-37.
- Kotob, Jenine . "Why Islamic Architecture in the United States is Failing American Muslims." ArchDaily. July 21, 2016. Accessed March 14, 2017. <http://www.archdaily.com/791724/why-islamic-architecture-in-the-united-states-is-failing-american-muslims>.
- Michell, George. *Architecture of the Islamic world: Its History and Social Meaning ; With a complete survey of key monuments and 758 illustrations, 112 in colour*. (Farnborough: Thames et Hudson, 2009): 3, 7, 16

Mosedale, Mike. "Somali diaspora." Wikipedia. January 07, 2017. Accessed March 06, 2017. [https://en.wikipedia.org/wiki/Somali\\_diaspora#cite\\_note-32](https://en.wikipedia.org/wiki/Somali_diaspora#cite_note-32).

Rabasca, Angel , Stacie Pettyjohn, Jeremy Ghez, and Christopher Boucek. "Deradicalizing Islamist Extremists." Report. RAND Corporation. 2010. [http://www.rand.org/content/dam/rand/pubs/monographs/2010/RAND\\_MG1053.sum.pdf](http://www.rand.org/content/dam/rand/pubs/monographs/2010/RAND_MG1053.sum.pdf) (Accessed October 2016): 190

Vrieze, John. *Earthly Beauty, Heavenly Art: Art of Islam*. (Amsterdam: O.V., 2000.): 33.